

RESPUBLIC OF AZERBAIJAN

On the rights of the manuscript

ABSTRACT

of the dissertation for the degree Doctor of Philosophy

THE DEVELOPMENT OF THE PROGRAM- INSTRUMENTAL SYSTEM FOR MONITORING, MODELING AND FORECASTING OF AIR POLLUTION IN BAKU CITY

Speciality: 3337.01– Infotmation-measuring and controlling
systems

Field of science: Technical sciences

Applicant: **Naira Xansuvar gizi Mustafazade**

Sumgait – 2021

The work was performed at National Aerospace Agency, The Institute of Space Researches for Natural Resources in "The Development of Mathware for Information-Measurement Complexes" department

Scientific supervisor: Doctor of Technical Sciences, professor
Tofik Ibragim oglu Suleymanov

Official opponents: Doctor of Technical Sciences, professor
Fazil Hezin oglu Alekberli

Doctor of Technical Sciences, professor
Kamal Xeyreddin oglu Ismayilov

Doctor of Technical Sciences, professor
Bayram Ganimet oglu Ibrahimov

Dissertation council FD2.25 of Supreme Attestation Commission under the President of the Republic of Azerbaijan operating at Sumgait State University

Chairman of the Dissertation council: Doctor of Technical Sciences, professor
Agil Hamid oglu Huseynov

Scientific secretary of the Dissertation council

Doctor of Philosophy in Technology, Associate professor
Turgay Kilim oglu Huseynov

Chairman of Scientific seminar:

Doctor of Technical Sciences, professor
Ali Hasan oglu Nagiyev

GENERAL CHARACTERISTICS OF WORK

The relevance of the theme and the degree of development.

Various variations in the concentration of pollutants in atmospheric air are also observed as a result of the widespread use of technical progress in various sectors of the economy, due to technological advances and changing the parameters of the ecosystem. Spontaneous use of natural resources has also led to deterioration of human habitat, climate change, reduction of stratospheric ozone levels, deforestation, and widespread desertification. At the same time, according to calculations, the current rate of growth indicates that by 2030 the world population will be over 9 billion, which will cause the problem of food and energy shortages. On the other hand, large hydrocarbon reserves, mining ore processing also have a significant impact on the physical, chemical and biological properties of the environment, creating conditions for air pollution. That is why the problem of environmental protection has attracted the attention of world scientists, expanded the arsenal of scientific research aimed at monitoring of atmospheric pollution, and made significant advances in the development of new technical facilities, the development of complexes and the commissioning of technological lines.

At present, environmental protection is of particular relevance in Azerbaijan for the creation of a software package for environmental pollution control and forecasting, due to the high level of public policy in Azerbaijan.

Different types of gas analyzers and chromatographs are widely used in world practice for qualitative and quantitative assessment of air pollutants. Although these measuring devices operate on different physical principles, it often allows for the simultaneous determination of the concentration of many contaminants, automatic calibration, and sufficient storage of data, and, if necessary, the transfer of a computer to an external computer. Meteorological parameters, which characterize the distribution of pollutants in the atmosphere, arise from the need to measure wind speed and

direction, air temperature and pressure, and humidity. At the same time, a number of tools and software have been developed in world practice to carry out environmental assessment of the environment, including the control of atmospheric pollution:

- collection of sensors that measure the concentration of air pollutants, as well as the main environmental parameters;
- programs for collecting, visualizing and storing received data;
- research processes modeling programs;
- forecasting programs based on acquired models;
- Presentation of research results;
- methods of direct monitoring, data collection, storage, processing and presentation;
- modeling and forecasting of air pollution.

At the same time, it should be noted that the placement of the aforementioned measuring devices on mobile devices allows monitoring in various cities and regions, and the measurement data is transmitted to the computer through special programs. In addition to that data, status and navigation information is transmitted to the computer, and through other software, that information forms part of the geographical information systems (GIS) database.

Taking into account all of the above mentioned, it is necessary to carry out a dissertation on the establishment of a single automated system that allows monitoring, modeling and prediction of atmospheric pollution by combining existing measuring devices, methods and programs.

The purpose and objectives of the study:

The main aim of the dissertation is to create a single software-instrumental system for collecting data on atmospheric pollution, modeling and forecasting, and developing automated procedures for presenting results.

In order to achieve the main goal, the following tasks have been put in the dissertation:

1. Determination of procedures for the software-instrumental system of monitoring, modeling and forecasting of atmospheric pollution.

2. Development of the principles of complementing the mobile complex with measuring devices and appropriate management software for assessing the atmospheric state parameters.

3. Development of mathematical model of distribution of pollution in surface atmosphere of Baku, experimental evaluation and modeling error estimation.

4. Development of software for forecasting of atmospheric pollution of Baku on the basis of multidimensional mathematical and statistical model.

5. Presentation of atmospheric pollution distribution in the form of thematic electronic maps.

Research methods.

The criteria for validating the theoretical results based on the experimental data were used in the implementation of the relevant provisions of regression analysis techniques, computer modeling techniques, geographic information technology, electronic mapping techniques.

Main provisions to be submitted for defense:

1. Structural scheme of software-instrumental system, including devices, processing programs and monitoring databases for measurement, monitoring, modeling and forecasting of atmospheric pollution in Baku.

2. A program with a tuning graphical interface that allows the selection of various technical parameters, data entry from analog and digital devices using the E14-140 controller.

3. Monitoring database management system that provides automatic recognition of files of various formats and data entry.

4. Model of polynomial atmospheric pollution with limited coefficients according to the required accuracy.

5. Program of short-term and medium-term atmospheric pollution prediction.

6. Methods for generating automatic image generation of electronic maps and distribution of pollutant concentrations in accordance with the selection parameter.

Scientific novelty of the research.

1. The structure of software-instrumental system for conducting, modeling and forecasting regional pollution of surface air in Baku was determined.

2. A new format of files containing status information, which includes the values of pollution and measured parameters of meteorological conditions, as well as the date, time and location of the observations, has been proposed.

3. A new mathematical and statistical polynomial model has been developed to indicate the dependence of the concentration of different pollutants on the meteorological factors.

4. A new functional model of an electronic monitoring map has been set up to automatically adjust the scaling, identify the coordinates of the observation points and improve the accuracy of the results obtained.

5. Methods of forecasting of atmospheric pollution on the basis of the developed model are proposed.

6. A new program has been created to demonstrate the visual presentation of pollution monitoring and forecasting results.

Theoretical and practical significance of the study.

1. The proposed program-instrumental system allows simultaneously to measure the concentration of the main pollutants of the atmosphere, as well as the meteorological parameters that influence these pollutants.

2. Software designed for data entry, storage, and visualization, and with an adjustment interface, is of particular importance in the rapid upgrade of the proposed software and hardware system.

3. Electronic cartographic presentation forms for modeling and forecasting of atmospheric pollution are important as a visual tool in the development of environmental programs in different regions, as well as in the planning of tourism and recreational networks.

4. Database created for monitoring and its management system can in the future be used as input for multifunctional modeling software.

Approbation and application of works.

The main provisions of the dissertation were discussed at the Scientific and Technical Council of the Institute for Space Researches of NASA and at the following scientific and technical conferences:

3rd International Scientific Conference of Young Researchers, dedicated to the 92nd anniversary of national leader Heydar Aliyev, Baku, Caucasus University, April 17-18, 2015; Scientific and technical conference "Youth and scientific innovation", dedicated to the 93rd anniversary of national leader Heydar Aliyev's birth; Baku, AzTU, 2016, Seminar dedicated to the 100th anniversary of Lieutenant-General Karim Karimov, "Achievements in Space Technologies", Baku, NASA, May 25, 2017.

19 scientific articles and conference materials (including four works in foreign countries) were published in various publications on dissertation topics.

The main results of the dissertation were realized in the following research works performed by the National Aerospace Agency (NASA) Institute for Natural Researches with the direct participation of the applicant:

- "Development of unified software for connection of computers of various measurement devices with the help of controllers E14-140" (SRI report, Baku, 2013-2014, 60 pages - executor);
- "Development of software and hardware complex for monitoring, modeling and forecasting of atmospheric pollution in the Absheron peninsula" (SRI Report, Baku-2017, 60 p. - responsible executive).

The name of the organization where the dissertation work is performed.

The work was performed at Azerbaijan Republic Ministry of Defence Industry, National Aerospace Agency division, The Institute of Space Researches for Natural Resources.

The total volume of the dissertation with an indication of the volume of the structural sections of the dissertation separately. The dissertation consists of an introduction, 4 chapters, the

conclusion, a list of literature used in 107 names and an appendix. The 1st chapter includes 42351 symbols, the 2nd – 33981, the 3rd – 47294, 4th -67307, and the work totally – 236018 symbols.

The **first chapter** of the dissertation provides an overview of the sources and main components of atmospheric pollution sources, and estimates for the most common atmospheric substances (MPH) values are in accordance with Azerbaijan, US and Russian standards. Information on the principles of some of the methods used to determine the level of atmospheric pollution has been explained, and the analysis of the basic methods of modeling of atmospheric pollutants has been done. The models used in the assessment of atmospheric pollution were classified according to different principles, showing the application of physical, mathematical and statistical methods (Fig. 1), and provided information on relevant software.

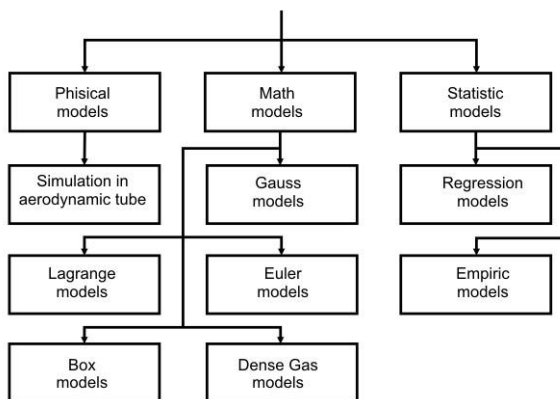

Fig. 1. Classification of models used in atmospheric pollution

This chapter then describes the common characteristics, functionality and application areas of the 50 models widely used in the assessment of atmospheric pollution and adopted in world practice, systematically presented in the form of tables. In general, the problem of predicting atmospheric pollution within certain starting and boundary conditions equation.

$$\frac{\partial q}{\partial t} + \sum_{i=1}^3 u_i \frac{\partial q}{\partial x_i} = \sum_{i=1}^3 \frac{\partial}{\partial x_i} k_i \frac{\partial q}{\partial x_i} - \alpha q \quad (1)$$

Here q is the concentration of the contaminant, t - time, x_i - coordinates, the average rate of displacement of the high-voltage, which is the coefficient that determines the change in concentration by the conversion of α - the direction of the x_i -axis. It has been shown that models of this type can only be used if there is information about all industrial facilities in the city. However, in most cases, only the monthly average data are known, and the possibilities for using such models in short-term forecasting are limited.

This chapter also provides a detailed overview of statistical modeling, showing that meteorological conditions, including humidity, temperature changes, have a significant impact on the distribution of pollution from the sun's light, cloud, wind speed and direction. Taking into account the mentioned factors, the statistical modeling problem was justified in the form of regression model $y = f(x_1, x_2, \dots, x_m)$. Here are the meteorological parameters that have a significant impact on the concentration of x_1, x_2, \dots, x_m contaminants, and the y is the concentration of the pollutant. It has been shown that such models are quite simple, considered useful in short-term forecasting, but not so effective in long-term forecasting issues. This chapter then describes the structure of the software-instrumental system for collecting, modeling and predicting data on atmospheric pollution, and explaining the functionality of its constituents (Fig. 2).

The emphasis here is on the procedures of the Interface program proposed for data entry. At the same time, a brief overview of the main functions of the forecasting and presentation software included in the complex is given, showing that all management operations are performed with the help of the user's graphical interface.

The **second chapter** describes the working principles of the mobile measurement laboratory operating in MAKА, the process of obtaining experimental data, and the functional capabilities of the

complete measuring devices.

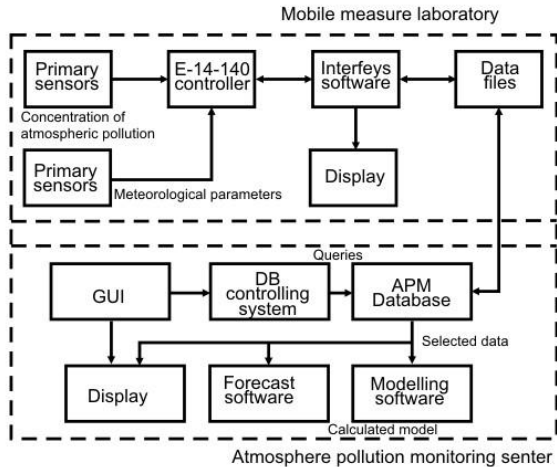

Fig. 2. Structure of software-instrumental complex for monitoring, modeling and prediction of atmospheric pollution:
 DB - database; APM - atmospheric pollution monitoring;
 GUI - graphical user interface.

These measuring devices are as follows:

- MX6 iBrid multigase analyzer;
- IVTM-7K humidity and temperature displaying device;
- PZ BP “Atmosphere” sampling device;
- GNOM-1 gas analyzer;
- MCK-AE1125 dosimeter-radiometer;
- “Asistent” Noise and Vibration Analyzer;
- PAA-10 aerosol radiometer.

We have shown the main advantages of the Interface program developed by NASA for the integration of measurements into the computer with the help of the E14-140 controller, and the algorithm for starting the program is given. Then the activities of that program were explained, the object model was developed, the correlation of the measurement data, the control signals and the interface configuration information (Fig. 3).

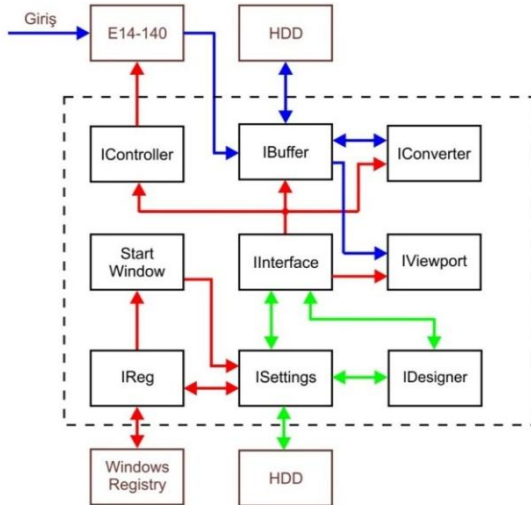

Fig.3. Interfeys Software object model

The objects of the program were IReg, ISettings, IDesigner, IInterface, IController, IBuffer, IViewport and IConverter. At the beginning of the letters, the letter "I" indicates that these objects belong to the Interface program. Then the features required for selecting one of the program launch options were explored separately, and the classification of the functions of the objects included in the structure was given.

This chapter also presents the structure of the algorithm for the output of on-board images, the principle of its operation, and the sequence of operations performed. It is shown that when switching to the measurement mode, the program ensures that the specified number of frames is read, as well as the channel number in the horizontal and vertical directions.

The procedures for measuring data processing with the help of EXCEL and MATLAB software are then described, and the functional steps of the program created to read the files (Fig. 4). The sequence of operations of the data input algorithm in EXCEL is presented, and the distribution of the data by channels within the numberOfFrames-based operations is performed (Table 1). This

chapter also describes the sequence of measuring data inclusion in MATLAB, and the measurement data graphically. At the end of the second chapter, the results of the performance of the software-instrumental complex for 2012-2013 based on the data of the selected local observation points in Baku (Table 2).

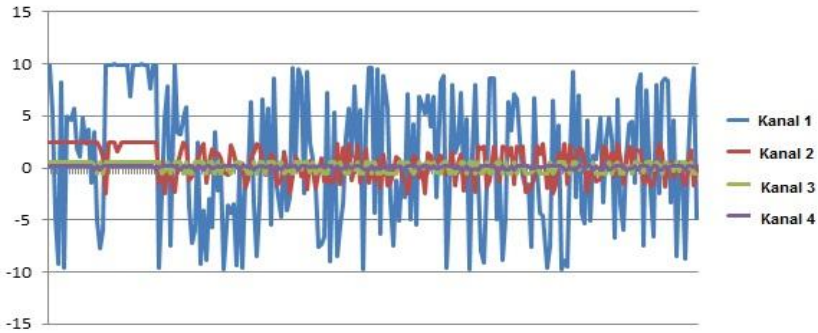

Fig. 4. Graphic description of the signal in EXCEL

Table 1.
Distribution of data by channels

Month	Average temp., °C	Air press., hPa	Average humidity, %	Wind average speed, m/s	Average rainfall, mm
1	5,5	1006,6	83	2,6	59,5
2	6,9	1010,6	90	2,5	58,2
3	8,8	1005,8	84	4,0	10,1
4	12,9	1007,5	81	2,6	55,9
5	20,2	1005,4	77	1,7	4,9
6	24,6	1000,8	72	2,4	7,0
7	26,4	999,6	67	3,3	6,0
8	25,8	1002,8	63	2,0	9,2
9	21,9	1002,8	72	3,2	44,9
10	15,9	1011,4	78	2,9	51,0
11	12,3	1011,9	81	2,3	52,0
12	5,6	1015,4	78	3,2	69,8
Mean	15,6	1006,7	77	2,7	35,7

The results of the observations and the average annual estimates of meteorological parameters from January to December 2013 are presented. The results have been shown to be the basis for the creation of a monitoring database.

Table 2.

Mean values of major pollutants in local observation points

Observation Point	Sulfur Dioxide	Nitrogen 4-Oxide	Hydrogen sulfide	CO	Furfural	Formaldehyde	Soot
Bibi-Heybat dist.	0,009	0,03	0,001	3			
NZS dist.	0,011	0,06	0,008		0,02	0,005	
Heydar Aliyev ave.		0,07		3	0,02	0,004	0,01
9-th m-dist.		0,04				0,005	
GaraGarayev ave.		0,05	0,001	3	0,02		0,01
Gurban Abbasov st.	0,009	0,05	0,001	3			
Sabunchu dist.	0,01	0,05	0,001	3	0,02		
Sharifzade st.	0,011	0,06		2	0,02	0,005	0,02
Khudu Mammadov st.	0,01	0,07	0,001	3			0,01

Chapter three describes the tables included in the structure of the atmospheric pollution monitoring (ACM) database - the measured parameters (Params), the observation points (Points) and the observations (Observations). The relationships between the main components of the ACM database are then schematically presented, in which case the functionality of each of the three tables is explained separately (Fig. 5). This chapter also shows the formats of a monitored data file, and provides an example of a file containing 11 line status information. In this example, variables such as station name, AR frequency, number of channels, number of frames, controller access number, and input range were taken as variables.

This section describes the interphase program format, XML format, EXCEL spreadsheet, and paper-based functions that support the storage of dimensional data, together with the use of all three files for complete and comprehensive processing of the data.

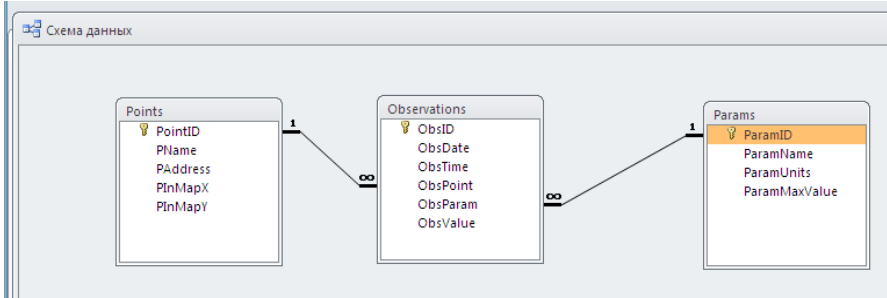

Fig. 5. Scheme of atmospheric pollution monitoring database

A database management system has been developed to address two key issues. The first major issue is the automatic entry of monitoring data from various types of files in the Interface program, XML file and EXCEL format. Therefore, all file type formats and algorithms for data overwriting are shown.

The second issue is the presentation of monitoring data in tabular and graphical form based on these criteria, as well as the choice of modeling and forecasting of pollution. To solve both problems, a special program with a graphical interface has been developed, and a database management software is provided (Fig. 6).

The program area consists of three panels. The left panel is designed to query the database and meet the criteria for the specific atmospheric pollutants, and is based on the location and time of the measurements. The central panel shows the output of the data corresponding to the query. The right panel consists of numerous electronic maps. The maps also show that the distribution of pollutants is based on Delone's triangulation, and a triangular map with a map of the monitoring area, measuring points and pollution distribution according to the selected parameter.

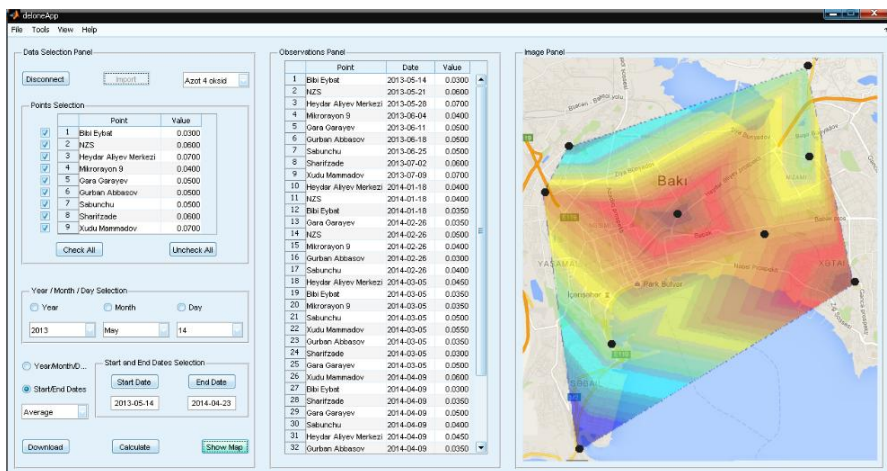

Fig. 6. Appearance of VB management software

An algorithm that performs automatic data entry after the XML file is proposed. The EXCEL table then describes the steps to create an electronic map of the monitored areas, with automatic data entry functions. In table 3 based on the electronic maps showing the observation points in Baku, the coordinates of the monitoring area were shown and the numerical values of the concentration of pollution were given.

Table 3.
Observer coordinates and pollution concentrations

№	X - coordinats	Y - coordinats	Consentration, mg/m ³
1	80	571	0,03
2	344	264	0,06
3	220	235	0,07
4	65	138	0,04
5	408	153	0,05
6	126	421	0,05
7	406	23	0,05
8	31	204	0,06
9	473	332	0,07

Chapter four discusses the creation of an atmospheric pollution model based on the group method of data handling (GMDH). In this case, a new algorithm was proposed based on the modification of the classical algorithm of the GMDH with a limited number of polynomial constraints. Then the sequence of activity of this algorithm was investigated, the matrix of convergence was taken in $n \times p$. Here n is the number of observations, when there is a number of arguments, the number of meteorological factors is calculated as $p = m + 2 + f$.

Here f is the number of degrees of freedom (the number of best models selected for the next iteration). The model iteration was then explained, the first m column of the matrix was filled with meteorological factors, the next column was filled with zero, and the next column was filled in, and the last column f was empty before the first iteration.

In this case, the function $X = x_i + x_j \times x_k$ or $X = [x_i \ x_j \times x_k]$ was chosen to calculate the iteration model. Here $i, j, k = 1, \dots, p$.

Then the models consisted of $\hat{Y} = A \times X$ output, or $\hat{Y} = A1 \times x_i + A2 \times x_j \times x_k$. presented in the form. The coefficients $A = [A1, A2]$ are calculated using the formula $A = (X' \times X)^{-1} \times X' \times Y$,

Where $X' = \text{Transpose}(X)$, Y is the values of the selected air pollutants (monitoring data). Thus, the functions of the GMDH software for modeling of air pollution have been defined, the block scheme and the external interface of the program are presented. On the left side of the graphical interface is the input panel, and on the right is the output panel. The review stages of the purchased models were then explained. If the next tested model meets the criteria specified first, then the algorithm will run out and the model parameters will be output. Otherwise the next model is checked, the best models of iteration f are written to the last column of the matrix f . The best iteration models are defined by the least squares method: $\min(\hat{Y}^2 - Y^2)$. All models in this series will be re-inspected until the search pattern is found. An object model of the blockchain developed in the MATLAB programming environment (Fig. 7) and an external modeling of the modeling software are given (Fig. 8).

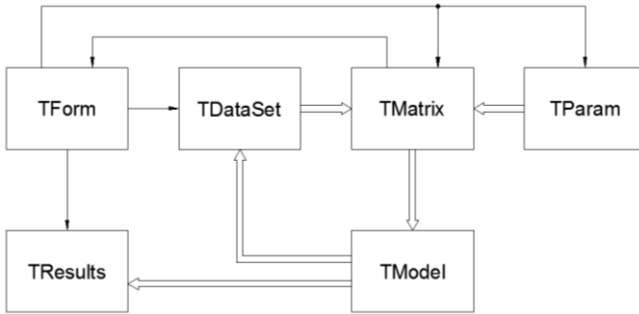

Fig. 7. Object model of GBMA program

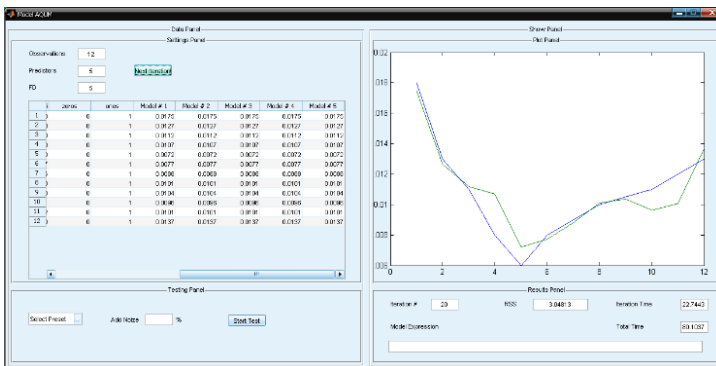

Fig. 8. Appearance of the modeling program

The program area consists of 2 main panels. On the left is the input panel, and on the right is the output panel. The left panel shows a table showing the current state of the convergence matrix. The next list of models is based on the matrix. On the right are the graphs of the pollution data and the atmospheric pollution values corresponding to the best model of the next iteration. Software tests have shown that after ten iterations, the modeling error is close to 3%. Based on the model obtained, the atmospheric pollution prediction was made, and the prediction error was less than 15% (Fig. 9). On the right side of the window, the monitoring revealed

that there was some difference between the forecast data and the data.

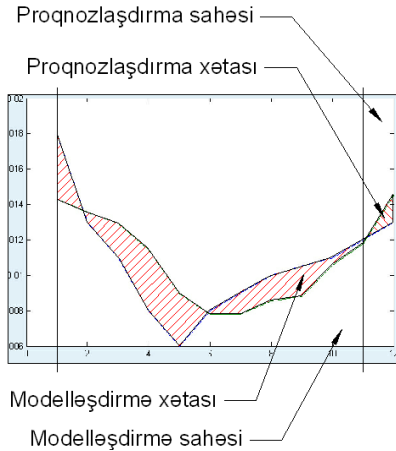

Fig. 9. Appearance of the EC prediction program

This chapter outlines the main components of the GMDH software model, explains the functionality of the prediction software structural areas, and places the monitoring maps within the geographic information technology capabilities, and provides a visual representation of the coordinates and all monitoring data.

Main results

1. The structure of software-instrumental system of data collection, modeling and forecasting based on the assessment of the impact of meteorological factors on the spread of atmospheric pollution is proposed.

2. Based on the comparative analysis of the characteristics of complementary measuring systems in the mobile measurement laboratory used at NASA, software has been developed with flexible adjustable interface for data entry and its operating procedures.

3. The procedures of entering the monitoring results from "Interfeys" software files, the XML files and EXCEL files to

monitoring database, and their management software have been developed

4. Monitoring methodology has been developed to allow the positioning of map points and the optimal route between them using the Web service.

5. Developed a program to build models of atmospheric pollution on the basis of GMDH;

6. A program of atmospheric pollution prediction was developed based on established models and expected estimates of meteorological factors.

7. A management system has been developed for selecting data of specific pollutants according to certain space-time criteria, displaying their distribution on electronic maps, and integrating the monitoring database into a GIS environment

The main provisions of the dissertation are reflected in the following published articles:

1. Ибадов А.А., Мустафазаде Н.Х., Гулузаде Р.К., Абдуллаева М.А. Оперативная обработка сейсмической информации программой «SEYSMOQRAF» // Известия АНАКА. – 2013. – Том 16, №4 (16). – с. 29-33.

2. Гулузаде Р.К., Абдуллаева М.А., Захаров И.Г., Мустафазаде Н.Х. Программа ввода данных с настраиваемым интерфейсом // Известия АНАКА. – 2014. – Том 17, №1 (17). – с. 32-35.

3. Рудой Е.М., Гаджиев М.М., Мустафазаде Н.Х. Применение программы "Interfeys" для мониторинга атмосферных загрязнений // Measuring and computing devices in technological processes. – Khmel'nitskiy. – 2015. – №3 (52). – с. 114-117.

4. Мамедов М.И., Мустафазаде Н.Х., Гафаров Р.Т. Модификация алгоритма GNM (Модифицированная Нумерация Геделя) для построения линейных регрессионных моделей // Известия АНАКА. – 2015. – Том 18, №2. – с. 64-67.

5. Агаев Ф.Г., Гулузаде Р.К., Мустафазаде Н.Х., Абдуллаева М.А. Объектная модель программы "Interfeys" // Известия АНАКА. – 2015. – Том 18, №2 (18). – с. 57-63.

6. Мамедов М.И., Гулузаде Р.К., Мустафазаде Н.Х. Применение метода группового учета аргументов для обработки данных мониторинга загрязнения атмосферы // Известия АНАКА. – 2015. – Том 18, №3. – с. 40-44.

7. Mustafazadə N.X. Atmosfer çirklənməsinin monitorinqi və modelləşdirilməsi üçün proqram-pribor kompleksi // Azərbaycan xalqının Ümummilli Lideri Heydər Əliyevin anadan olmasının 92 illiyinə həsr olunmuş Gənc Tədqiqatçıların III Beynəlxalq Elmi Konfransı. Qafqaz Universiteti. – 17-18 Aprel 2015. – s. 339-340.

8. Mustafazadə N.X. Bakı şəhərinin atmosfer çirklənməsinin monitorinqi və modelləşdirilməsi // Azərbaycan Texniki Universiteti. Elmi Əsərlər. – 2015. – Cild 1, № 4. – s. 175-181.

9. Mustafazadə N.X. Atmosfer çirklənməsinin monitorinqinin

elektron xəritəsinin yaradılması // Azərbaycan Texniki Universiteti. Azərbaycan xalqının ümummilli lideri Heydər Əliyevin anadan olmasının 93-cü ildönümünə həsr olunmuş tələbə və gənc tədqiqatçıların “Gənclər və elmi innovasiyalar” mövzusunda Respublikla elmi-texniki konfransının materialları. – 2016. – s. 205-207.

10. Mustafazadə N.X., Sadıqov Q.E. Atmosfer çirklənməsi monitorinqinin verilənlər bazasının yaradılması // Azərbaycan Texniki Universiteti. Azərbaycan xalqının ümummilli lideri Heydər Əliyevin anadan olmasının 93-cü ildönümünə həsr olunmuş tələbə və gənc tədqiqatçıların “Gənclər və elmi innovasiyalar” mövzusunda Respublikla elmi-texniki konfransının materialları. – 2016. – s. 209-211.

11. Сулейманов Т.И., Мустафазаде Н.Х., Гулузаде Р.К. Обработка данных мониторинга атмосферных загрязнений города Баку // Приборы и системы. Управление, контроль, диагностика. – 2016. – №10. с. 41-45.

12. Süleymanov T.İ., Mustafazadə N.X. Bakı şəhərində atmosfer çirklənməsinin monitorinqi üçün elektron xəritənin yaradılması // Milli Aviasiya Akademiyasının Elmi Əsərləri. – 2016. – №2. – s. 118-127.

13. Mustafazadə N.X. Abşeron yarımadasında atmosfer çirklənməsinin monitorinqi, modelləşdirilməsi və proqnozlaşdırılmasının aparılması üçün proqram kompleksinin işlənilməsi // АМАКА Xəbərləri. – 2017. – Cild 20, №3 (20). – s. 28-33.

14. Süleymanov T.İ., Mustafazadə N.X. Bakı şəhərinin atmosfer çirklənməsinin modelləşdirilməsi // Sumqayıt Dövlət Universiteti. Elmi xəbərlər. Təbiət və texniki elmlər bölməsi. – 2018. – Cild 18, №2. – s. 37-41.

15. Mustafazadə N.X., Əliyeva G.X. Atmosfer monitorinqində nəqliyyat xərclərinin azaldılması üsulu. // “Azərıtifaq” Azərbaycan Kooperasiya Universiteti. “Kooperasiya” elmi-praktiki jurnal. – 2018 - №3 (50). – s. 148-153.

16. Süleymanov T.İ., Mustafazadə N.X. Atmosfer çirklənməsinin

monitorinqi, modelləşdirilməsi və proqnozlaşdırılması üçün program-instrumental sisteminin modernləşdirilməsi // АМАКА Хəbərləri. – 2019. – Cild 22, №1 (22). – s. 42-47.

17. Сулейманов Т.И., Мустафазаде Н.Х., Гулузаде Р.К., Гаджиев М.М., Иванова Л.В. Автоматизация моделирования и прогнозирования атмосферного загрязнения // Automation of technological and business-processes. – 2019. – Vol.11, №1. – с. 47-52.

18. Mustafazadə N.X. Atmosfer çirklənməsinin monitorinq verilənlərinin emalının və modelləşdirilməsinin avtomatlaşdırılması // International Conference: Modern information, measurement and control systems: Problems and perspectives 2019. – Baku, Azerbaijan, July 01-02, 2019. – s. 260.

19. Мустафазаде Н.Х. Построение карты качества атмосферного воздуха города Баку // Ученые записки Крымского федерального университета им. В.И.Вернадского. География. Геология. – 2020. – Том 6 (72). №2. – с. 318-325.

Personal service of the author in scientific articles published together with co-authors:

[7, 8, 9, 13, 18, 19] – works freely prepared by the author

[1, 2, 3, 4, 5, 6, 10, 11, 12, 14, 15, 16, 17] - researches, analysis and modeling, processing of results.

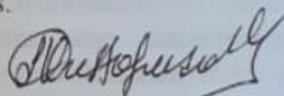

The defense will be held on 18 may 2021 at 13⁰⁰ at the meeting of the Dissertation council FD2.25 of Supreme Attestation Commission under the Prezident of the Republic of azerbaijan operating at Sumgait State University.

Address: Sumgait city., district 43

Dissertation is accessible at the Sumgait State University Library.

Electronic versions of dissertation and its abstract are available on the official website of the Sumgait State University -

www.sdu.edu.az.

Abstract was sent to the required addresses on 15 april 2021.

Signed for print: 12.04.2021

Paper format: 60*84^{1/16}

Volume: 34161

Number of hard copies: 40